

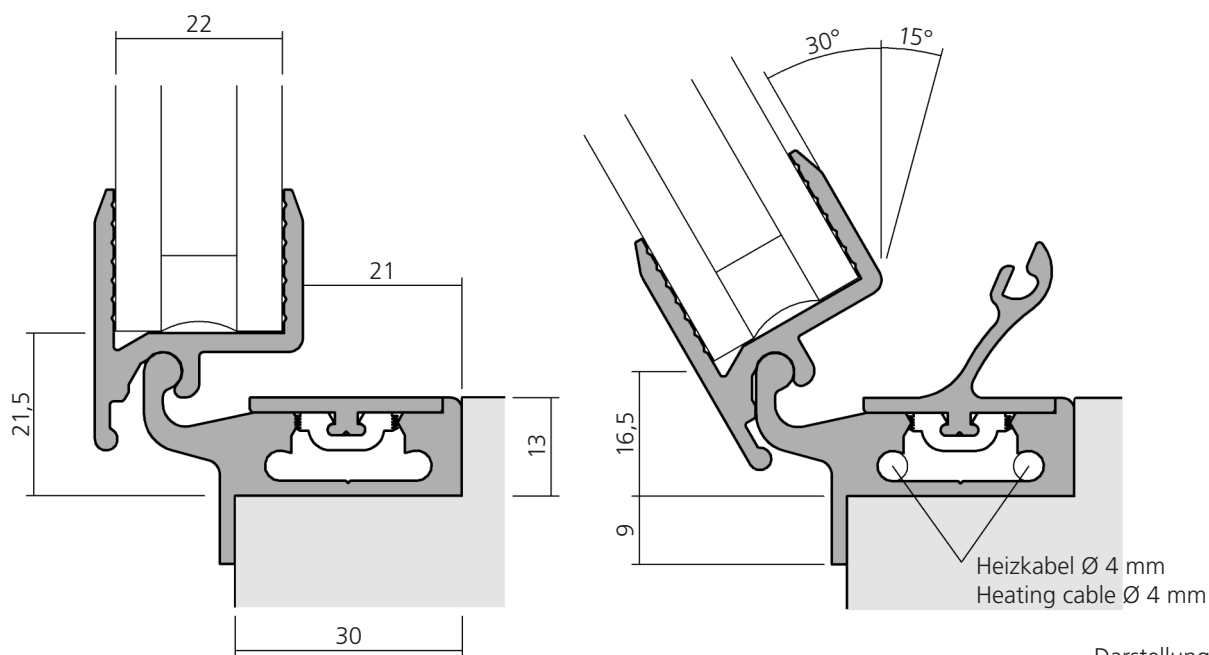
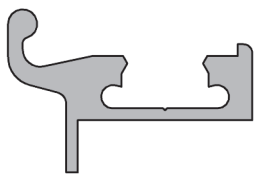
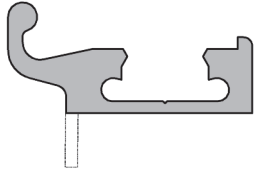
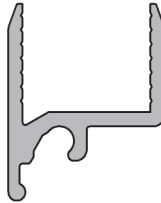
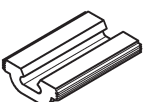

Kippbeschlag für Isolierglas
 Tilting armature for insulating glass

223

 Darstellung
 Image 100%

	Anschlagprofil, Aluminium Stop profile	6000 mm	17061
		6000 mm abgespalten	17068
	Glashalteprofil, Aluminium Glass holding profile	6000 mm	12253
	Abdeckprofil, Aluminium Covering profile	6000 mm	17038
	Abdeckprofil, Aluminium Covering profile	6000 mm	17039
	Profilverbindung, Kunststoff Profile connection, plastic		22434