

Drehtürbeschlag
Swinging door armature

250

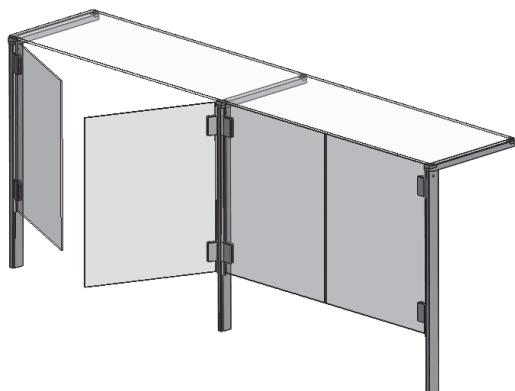
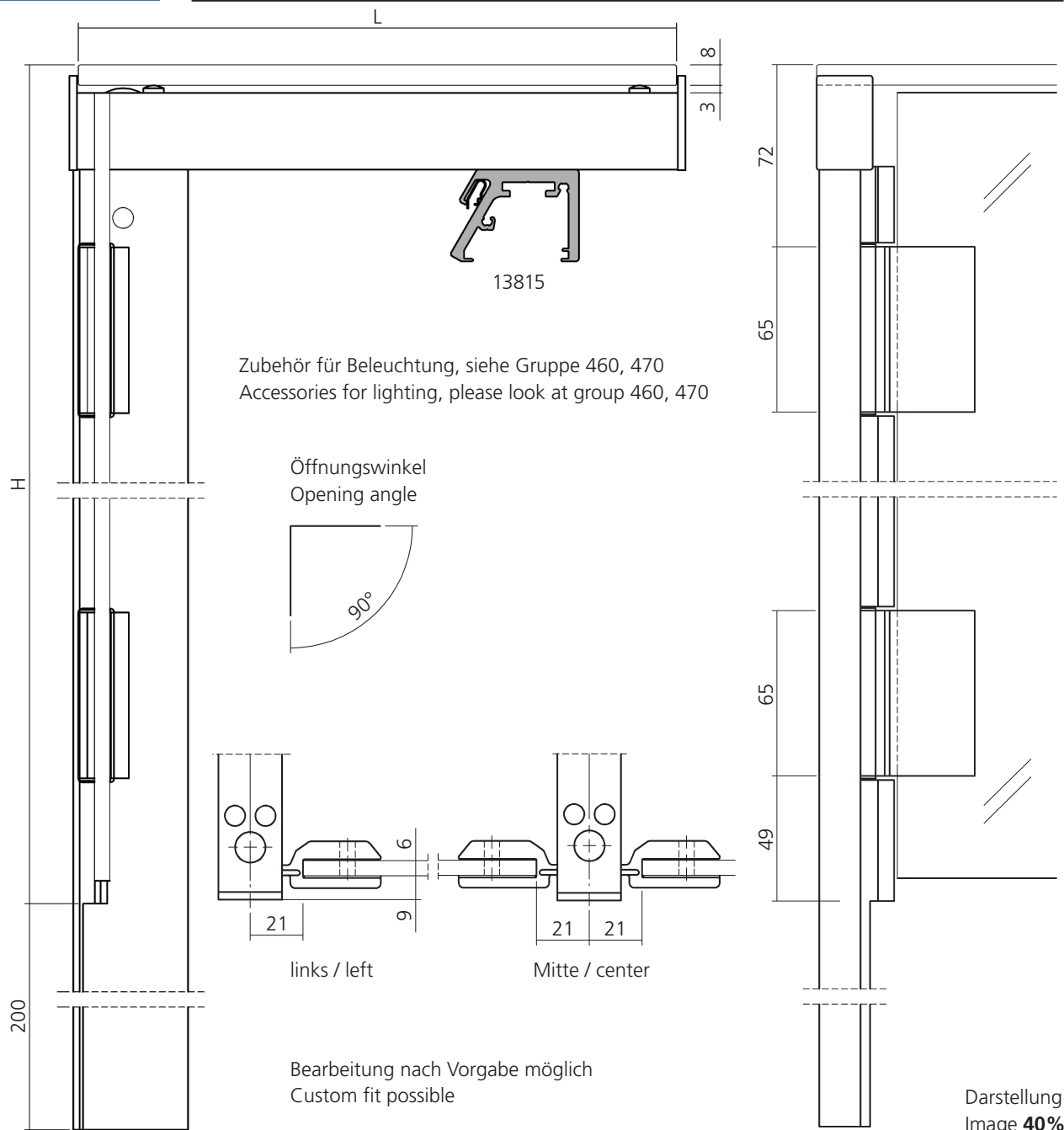

Drehtürbeschlag für senkrechtes Frontglas
max. Frontglasgröße B = 625 mm, H = 700 mm
max. Deckglastiefe L = 450 mm
Öffnungswinkel 90°

Swinging door fitting for vertical counter
max. front glass size B = 625 mm, H = 700 mm
max. upper glass size L = 450 mm
opening angle 90°

Wir empfehlen ESG - Glas in allen
Thekenaufbauten zu verwenden.

We recommend always toughened
safety glass for all our systems.

Drehtürbeschlag
Swinging door armature

250

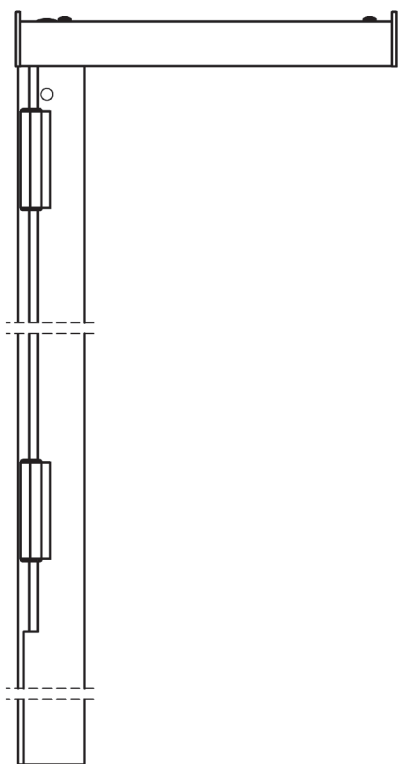

Trägerprofil
Bracket profile

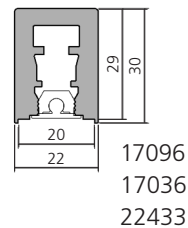

Stützenprofil links / rechts
Support profile left / right

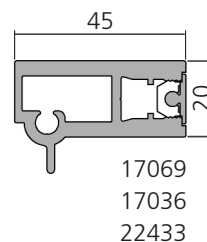

Stützenprofil Mitte
Support profile center

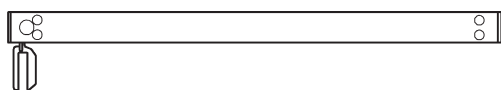
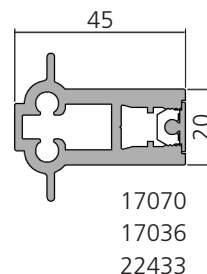

Stütze links
Support left

Abmessungen nach Angabe **25250**
Dimensions according to indication

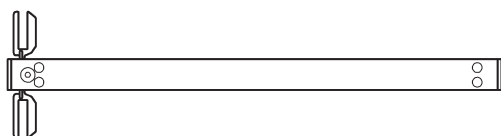

Stütze Mitte
Support center

Abmessungen nach Angabe **25252**
Dimensions according to indication



Stütze rechts
Support right

Abmessungen nach Angabe **25251**
Dimensions according to indication

Frontglas ESG 6 mm
Front glass ESG 6 mm

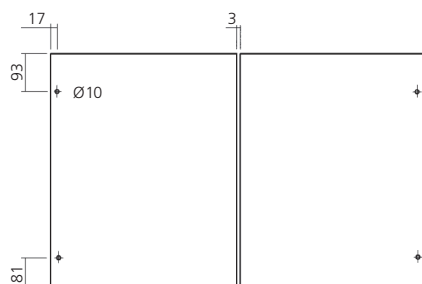

Drehtürbeschlag
 Swinging door armature

250

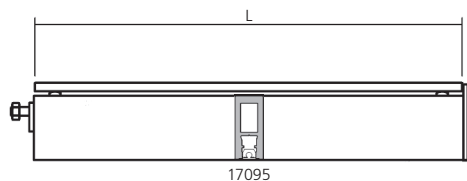

 Glaslänge L = 150 - 450 mm
 Glass length dimension L = 150 - 450 mm

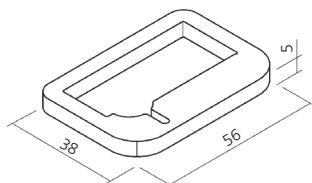
 Zwischenträger 90°
 Intermediate bracket 90°

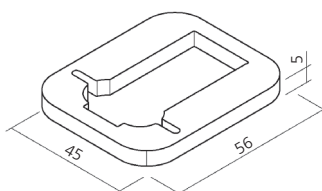
 L nach Angabe **25240**
 L according
 to indication

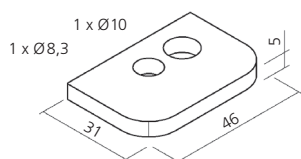
 Übergroßfrossette, Aluminium
 Retaining-collar

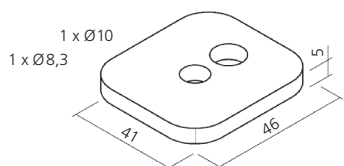
 rechts/right **25274**
 links/left **25275**

 Übergroßfrossette, Aluminium
 Retaining-collar

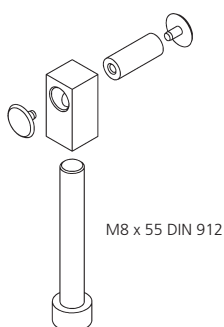
 Mitte/center **25276**

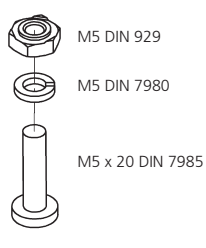
 Rosette, Aluminium
 Collar

 rechts/right **25277**
 links/left **25278**

 Rosette, Aluminium
 Collar

 Mitte/center **25279**

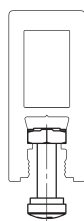
 Verschraubung
 Screw connection

 90° / 70° **26439**

17095 / 17096

 Befestigungssatz
 für Beleuchtungsblende
 13813, 13815, 13816
 Fixing set
 for light shield
 13813, 13815, 13816
SC013