

Hebebeslag  
Lifting armature

# 350

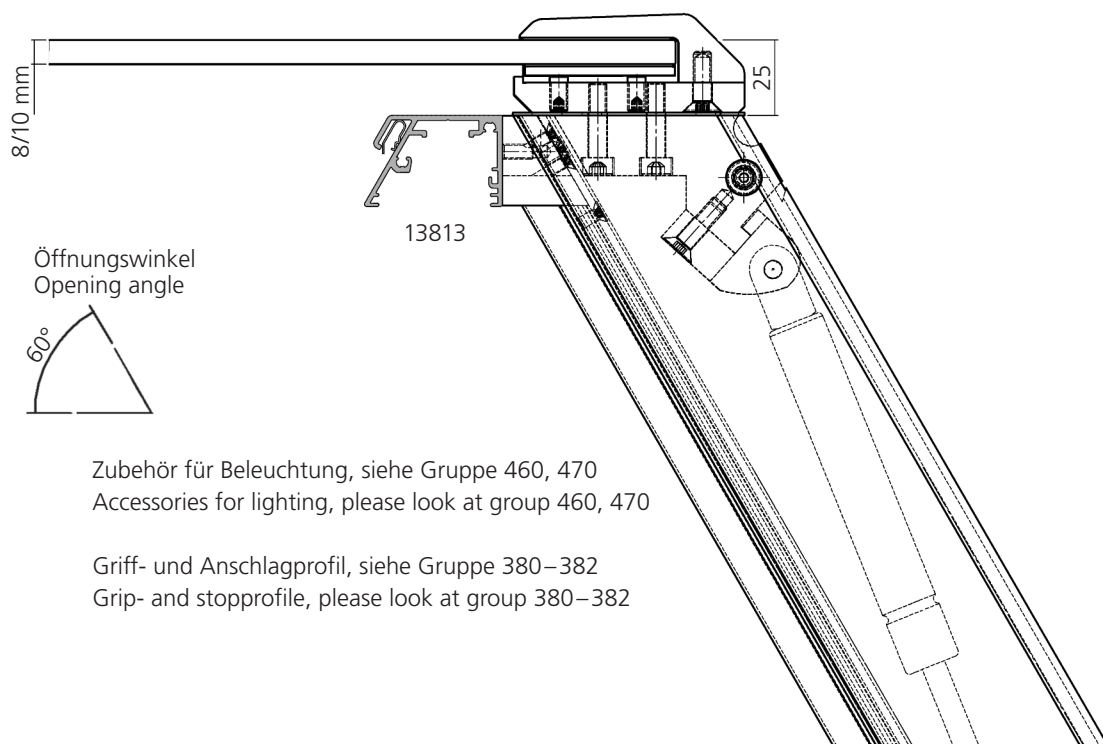

Zubehör für Beleuchtung, siehe Gruppe 460, 470  
Accessories for lighting, please look at group 460, 470

Griff- und Anschlagprofil, siehe Gruppe 380–382  
Grip- and stopprofile, please look at group 380–382

Darstellung  
Image **40%**

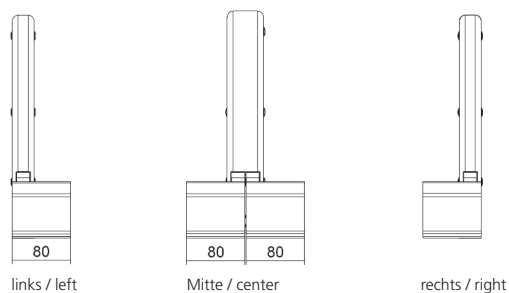

Darstellung  
Image **10%**

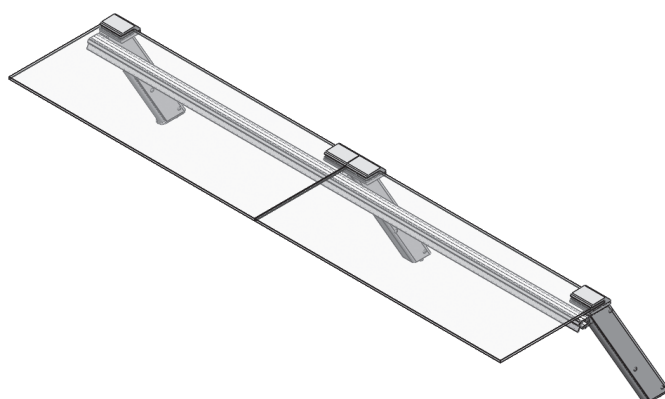

Hebebeslag  
max. Glaslänge 1300 mm  
max. Deckglastiefe 500 mm

Lifting armature  
max. glass length 1300 mm  
max. upper glass size 500 mm

Wir empfehlen ESG-Glas in allen  
Thekenaufbauten zu verwenden.

We recommend always toughened  
safety glass for all our systems.

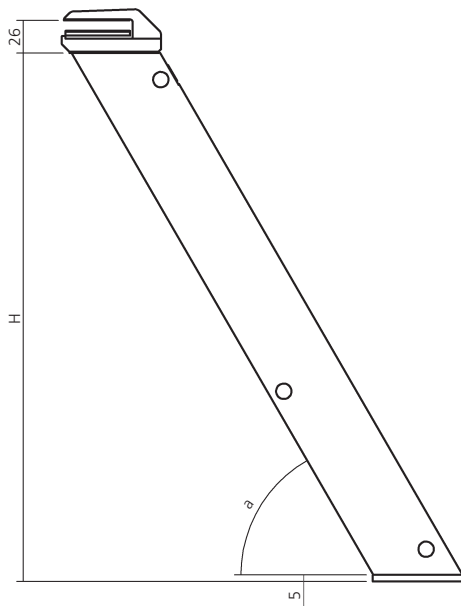

Höhe H = 400 mm  
 Neigung a = 35° – 70°  
 in Schritten von 5°

Height H = 400 mm  
 Degree a = 35° – 70°  
 in steps of 5°

**Sondermaße auf Anfrage**  
**Special dimensions on request**

Gasfeder ist nicht im Lieferumfang enthalten.  
 Gas ram not included in delivery.



Endstütze  
 aus Profil 11951  
 End support  
 out of profile 11951

Glas / Glass  
 8 mm  
 10 mm

**22645**  
**22665**

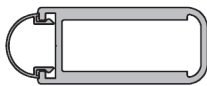

Endstütze  
 aus Profil 11962/12027  
 End support  
 out of profile 11962/12027

Glas / Glass  
 8 mm  
 10 mm

**22646**  
**22666**

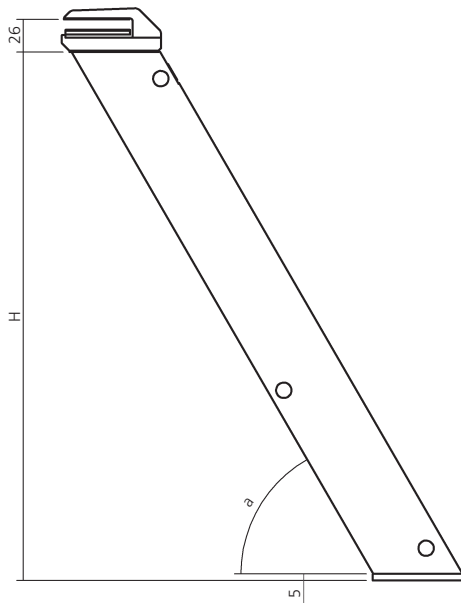

Höhe H = 400 mm  
 Neigung a = 35° – 70°  
 in Schritten von 5°

Height H = 400 mm  
 Degree a = 35° – 70°  
 in steps of 5°

**Sondermaße auf Anfrage**  
**Special dimensions on request**

Gasfeder ist nicht im Lieferumfang enthalten.  
 Gas ram not included in delivery.

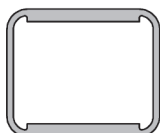

Mittelstütze  
 aus Profil 11952  
 Central support  
 out of profile 11952

Glas / Glass  
 8 mm  
 10 mm

**22647**  
**22667**

Hebebeschlag  
Lifting armature

# 350

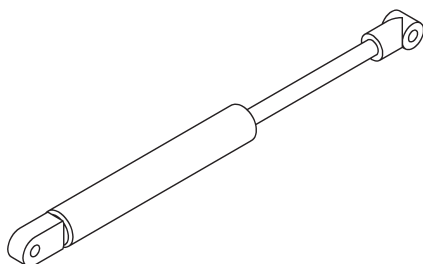

Gasfeder – Liftomat	300 N	<b>22633</b>
Gas ram – Liftomat	400 N	<b>22635</b>
	500 N	<b>22684</b>
	600 N	<b>22648</b>
	700 N	<b>22685</b>
	800 N	<b>22686</b>

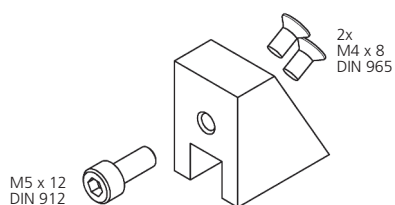

Blendenhalter, Aluminium Shield holder	Neigung nach Angabe Degree to indication	<b>22657</b>
---	---	--------------

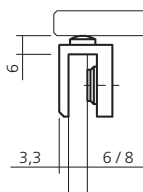
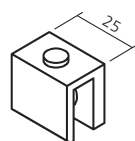

Glasauflage für senkrecht stehende Scheibe Glass support for vertical pane	<b>22653</b>
---	--------------

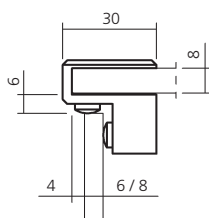
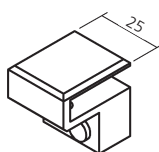

Glasanschlag für senkrecht stehende Scheibe Glass stop for vertical pane	<b>22660</b>
---	--------------

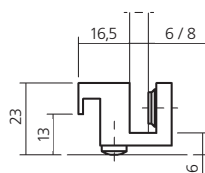
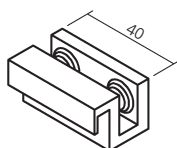

Griff für Frontscheibe Grip for front pane	<b>22661</b>
---	--------------